

SWEEPER-G

SPEED GATES

Compared to the standard Sweeper model, the Sweeper-G offers a more compact design featuring a single blade, which provides a passage width of 500mm. With the Sweeper-G, you can achieve the desired level of functionality and performance while staying within your budget. This speed gate turnstile provides a cost-effective solution without compromising on quality, making it a suitable choice for projects that require efficient organization of multiple passage lines. Opting for the Sweeper-G model ensures efficient space utilization without sacrificing functionality.



*PERFECT SOLUTION COMBINES FUNCTIONALITY WITH
CONTEMPORARY AESTHETIC DESIGN*



500
mm
PASSAGE
WIDTH



30
pers/min
SINGLE ACCESS
FLOW RATE



60
pers/min
FREE ACCESS
FLOW RATE



0,8
sec
OPENING / CLOSING



41
PROTECTIVE LEVEL



ANTI-TAILGATING



BI-DIRECTIONAL



ACCESS CONTROL
SYSTEM



MANUAL
CONTROL

Key features:

- BMDrive® - a reliable mechanism with a powerful BLDC gear motor ensures long-term, maintenance-free operation.
- The speed gate is equipped with a smart self-diagnostic system.
- An innovative controller with an OLED display and buttons allows for easy setup and configuration without the need for special programmers.
- Digital control of force and leaf speed, combined with safety sensors, prevents accidents and ensures the safety of individuals, even in cases of unauthorized passage.
- The sensor system enables the detection of individuals with luggage or allows for a free exit without the need for identification.
- Elegant cabinets come equipped with integrated LED lighting that displays the access status and card reader area.
- The housing design and top lid can be customized to meet specific preferences.
- Can be seamlessly integrated with any type of access control system.
- A wired remote control panel is included as part of the standard kit.
- Low power consumption.
- In the event of a power failure, the leaves can be manually opened (fail-safe).



www.tiso.global



+380 (44) 291-21-11



sales@tiso.global



TECHNICAL SPECIFICATIONS

Model	Sweeper-G
Cabinet width, mm	208
Cabinet length, mm	1318
Cabinet height, mm	1010
Passage width, mm	500
Opening/closing time, sec	0,8
Mechanism	BMDrive® servodrive (BLDC)
Blocking system	ToothLock®
Emergency mode (fire-alarm)	Free entry/exit (leaves are opened automatically)
Power fail	Fail safe (gates could be opened manually — standard)
MCBF, cycles	10 000 000

Electrical Specifications:

Maximum power consumption, W	160
Voltage	From the AC (100-240)V, 50/60Hz; from a DC source 12 V
Indication	DotLights®, RFIDLights®, EdgeLights®

Finishing

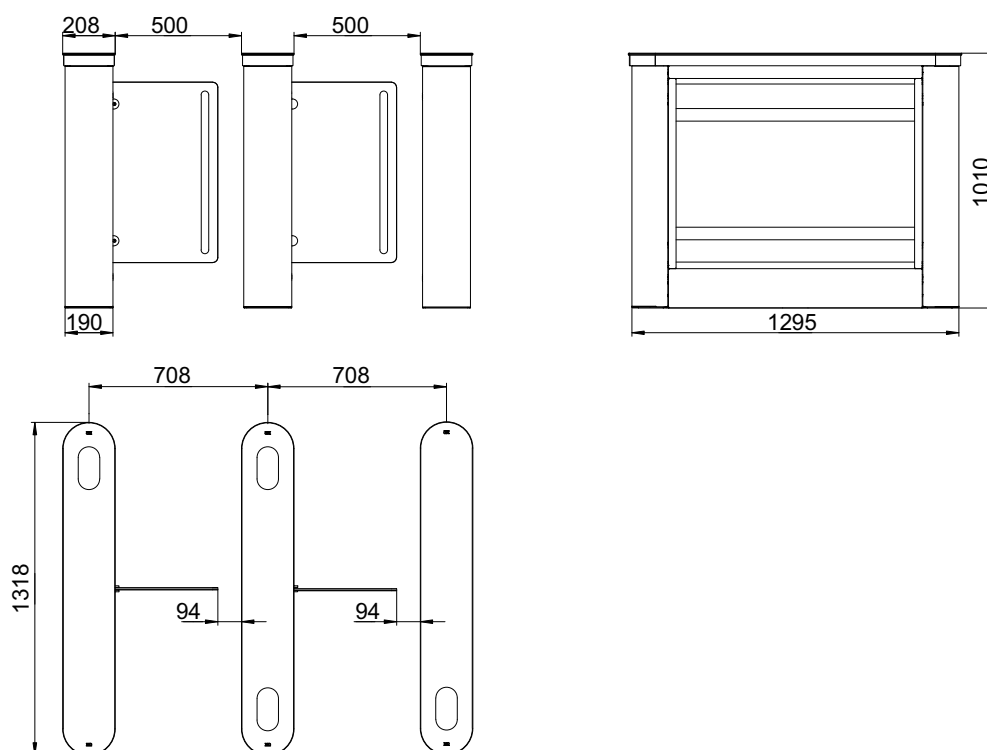

Standard housing	Brushed SS AISI 304
Available housing	Brushed SS AISI 316; Polished SS AISI 304; Polished SS AISI 316; Powder coated RAL



Dimensions for solid glass top lid

Specifications are subject to change without prior notice



 www.tiso.global
 +380 (44) 291-21-11
 sales@tiso.global



STANDARD FEATURES

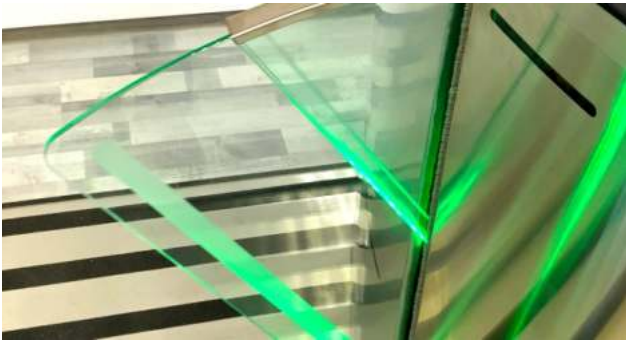

LEAFLIGHT®

Impressive illumination of the leaves can be in three colors (standard), marking the status of passage: blue - standby mode; green - access authorized; red - access denied.



CONTROL PANEL

The wired control panel goes in a standard set. Allows to implement a single passage, a free passage, as well as blocks an access and activates the anti-panic function.



SAFETY SENSORS, ANTI-TAILGATING FUNCTION

High-precision sensors that identify the unauthorized passage of two or more people (antitailgating function). At the same time safety sensors guarantee safe passage for people with luggage or trolleys - the gates won't close until the person finishes the passage.



UPS FUNCTION

A complex UPS system that automatically switches power to work from the back-up battery. This allows you to use all the functions of the speed gate in case of power fail.



LED INDICATIONS

Bright and attention-grabbing RFIDLIGHT® (LED light of card reader area) and DotLight® (LED lighting display showing access status).



PLACE FOR RFID INSTALLATION

Place for RFID installation is provided in the standard configuration of the speedgate.

ADDITIONAL OPTIONS /

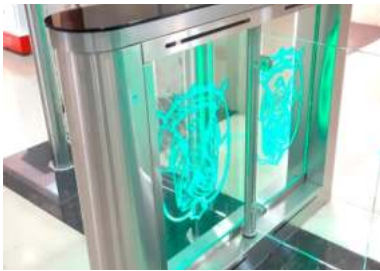

PATTERN APPLICATION

Unique signatures, customized patterns, logos and others can be placed on the leaves, housing or top lid of speed gates.

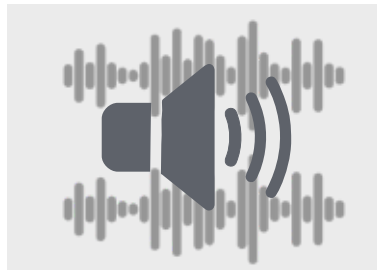

MP3 AUDIO MODULE

Audio signals for unauthorised access / authorised access / closing / opening / alarm.



KEYFOBS FOR RADIO REMOTE CONTROLLER

Minimalistic keyfobs for opening and blocking the passage.



INTEGRATION OF CUSTOMIZED ACS

Any access control systems upon request (e.g. RFID device, coin acceptor push button, fingerprint, face recognition, barcode and QRcode reader).



TWIC WIRELESS CONTROL PANEL

TiSO TWIC were developed for the remote control of multiple lines of turnstiles. The space saving 10" touch screen display can be located at a reception desk or within security control areas.



SUPER CAPASITOR

Maintenance of a free power package for emergency automatical one time opening of the speed gate.



FOOTPRINT ILLUMINATION

LED illumination of the footprint of the speed gate housing. The color of the light may vary depending on your request.

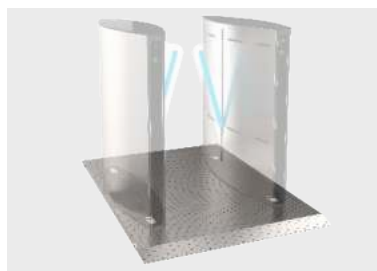

MOBILE PLATFORM

Ensures quick temporary speed gate installation. As well as can be installed in areas where it is impossible to drill the floor.



EXIT BUTTON

A convenient option that allows you to organize an exit by using a touch free button.

ADDITIONAL OPTIONS /

RANDOMIZER
RANDOMIZER
RANDOMIZER

RANDOMIZER

This mechanism automatically randomly selects a person for verification, without the influence of the human factor.



CARD COLLECTOR INTEGRATION

Possible to integrate the automatic card collector into the speed gate housing.



RFID READERS T-PROX MINI

Reader operates with 125 kHz cards, Mifare, Mifare Plus and mobile credentials U-Prox ID over NFC and over 2.4 GHz radio.



JUMPING OVER TOP LEAD ALARM

Weight sensors detect over 10 kg impact on the top lid and activate alarm.



COUNTER OF PASSAGES

Automatic counting of the number of passes.

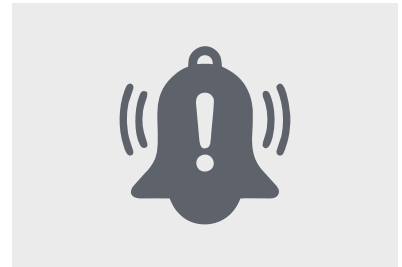

ALARM BUZZER

Sound alarm during unauthorised access.